



These instructions and the images herein are proprietary. Any unauthorized reproduction is prohibited.

GVW-255-919-059

## Gauge Cluster Printed Circuit Replacement

**DISCLAIMER:** This kit has been designed for easy installation. However, it does involve some wiring. The installation of this kit is not within everyone's ability. Read through these instructions carefully and decide if installing it is for you. If not, please take your vehicle to an automotive electrician. Wiring errors can be troublesome and hazardous.



**NOTE:** Watch our [install video](#) on Gowesty.com before you begin! This product is plug-and-play for all 1986-91 Vanagons with digital clock, tachometer, and dynamic oil pressure system. If you have a 1980-85 Vanagon, you will need to refer to the **RETROFIT** section of these instructions and complete some extra steps in order to install this kit correctly.

### Assembly of the Main PCB:

1. Start by removing the gauge cluster and uninstalling the original flexible circuit foil from the back of the cluster.
2. **THIS STEP IS VERY IMPORTANT:** First, determine if you have the stock dynamic oil pressure system (9-pin connector [6 pins in the speedometer] on the back of the speedometer). Generally, only vans from 86-91 will have the dynamic oil pressure warning system. Next, take the main PCB board and locate the small dip-switch on the back (shown by the red arrow in the diagram at right).
  - If you **DO NOT** have a dynamic oil pressure warning system, you will need to remove the protective film from the dip switch and move it into the up (ON) or "DISABLE DYN. OIL" position.
  - If you **DO** have a dynamic oil pressure warning system, make sure that the dip-switch is in the down or OFF position. **The switch should already be in this position when it arrives.** This will enable the dynamic oil pressure warning system built into the main PCB to function properly. *Note: The new dual oil pressure warning system will light the oil pressure LED solid when using the low pressure switch (activated below 2300rpm). The oil pressure warning LED will blink with an audible high pitch beeping alarm when using the high oil pressure switch (above 2300 rpm).*
3. Locate the indicator LEDs; they will need to be cut to the appropriate lengths before installation using the white plastic spacers as measuring guides. Find the **green** and **blue** LEDs. Take a felt-tip marker and color the longer LED leg. Now locate the **longer** (11/16") of the two white spacers included in the kit. The **blue** and **green** LED legs will need to be cut to the length of this spacer. Insert the LED into the spacer and cut the **blue** and **green** LED legs the length of the spacer. Now remove the spacer and insert the LEDs into the correct locations on the main circuit board. The **green** led will be placed in the sockets labeled "TURN" while the **blue** led will be placed in the sockets labeled "HI." Insert the leg that you marked with the felt-tip marker in the socket marked with the "+" symbol. This ensures the LED is inserted in the correct orientation. The LEDs should 'snap' into place and be held securely.

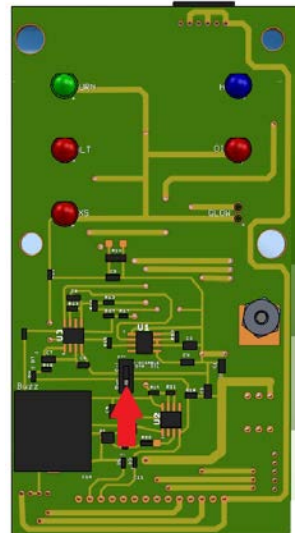

Now repeat the same procedure using the **shorter** (5/8") of the two white spacers included in the kit to cut the **red** LEDs to the appropriate length (some vans don't use an OXS light). *Note: This kit comes with an extra set of indicator LEDs.*

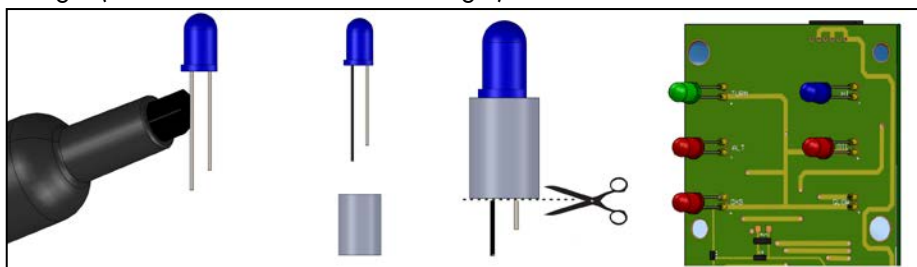



These instructions and the images herein are proprietary. Any unauthorized reproduction is prohibited.

## GVW-255-919-059 Gauge Cluster Printed Circuit Replacement

4. Install the voltage regulator with the included hardware (machine screw and large spacer/heat sink) as shown in the diagram below. Now set the main PCB assembly aside—we will come back to it later.

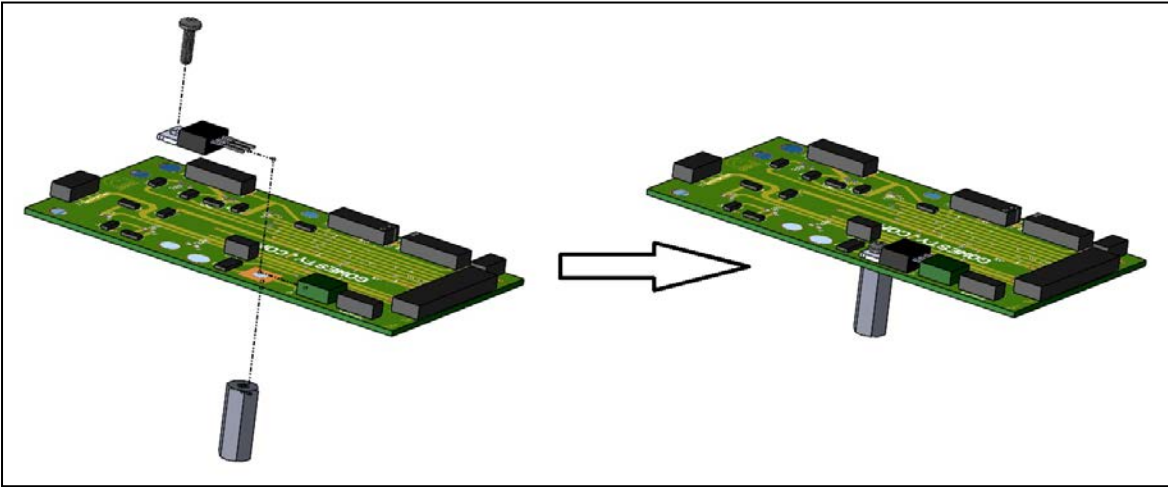

If you have an analog clock please **SKIP** steps 5 through 8 and **CONTINUE** to step 9.

5. Find the tachometer PCB and clip pictured to the right. Snap the tachometer PCB into the Clip as Shown in the figure below.

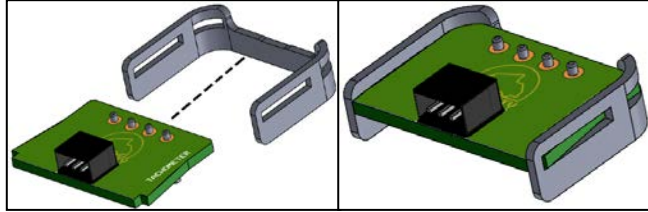

Place the tachometer PCB on the back of the tachometer as shown. The 4 female sockets must line up with the male pins of the tachometer. This can be tricky to get the first time. Just take your time and make sure that the tachometer PCB feels nice and secure once installed. If it moves around easily, the pins are likely **not lined up**. **NOTE:** Some '84 and '85 tachometers have the plastic retention tab molded at the *bottom* of the plug, rather than the top. If this is the case you will need to install the tach board in the upside down position which will require re-wiring of the tachometer wiring harness. See the retrofit section at the end of these instructions.

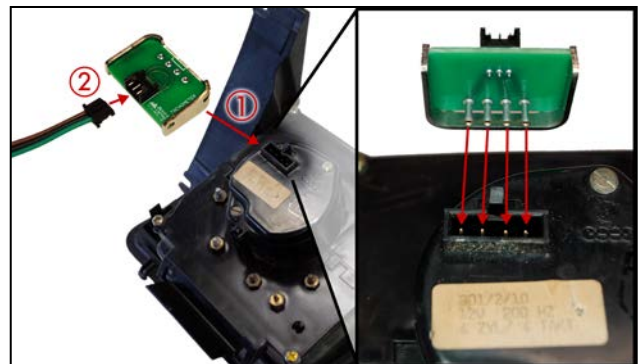

6. Now locate the tachometer harness that is included in your kit (pictured on the right). Plug the 4-pin connector into the receptacle on the tachometer PCB unit. We will install the other side of this harness when we install the main PCB board in a later step.





These instructions and the images herein are proprietary. Any unauthorized reproduction is prohibited.

## GVW-255-919-059 Gauge Cluster Printed Circuit Replacement

7. Find the digital clock PCB unit pictured on the right. Place the digital clock PCB on the back of the digital clock as shown. The 2 female receptacles must line up with the male pins of the digital clock. This is easiest to do if you remove the clock from the cluster first, but can be done with the clock installed. Once the pins are lined up and mated, attach the digital clock PCB to the digital clock using the two small Phillips screws included in the kit. Do not over tighten these screws. Again, this is designed to be a semi-permanent install and doesn't have to be removed from the clock.

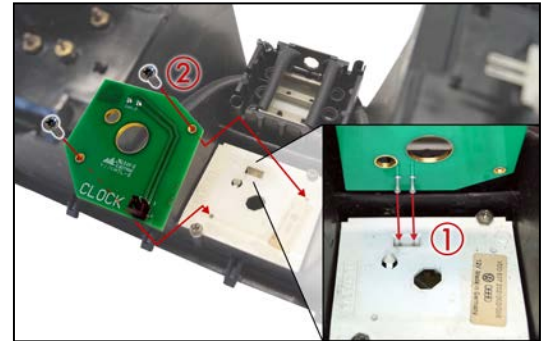

8. Locate the digital clock harness included in your kit (pictured at right). Install the illumination LED socket into the hole on the back of the digital clock by twisting it 90 degrees. The two-wire connector on this harness will plug into the receptacle at the base of the digital clock PCB. We will install the other side of this harness when we install the main PCB board in a later step.

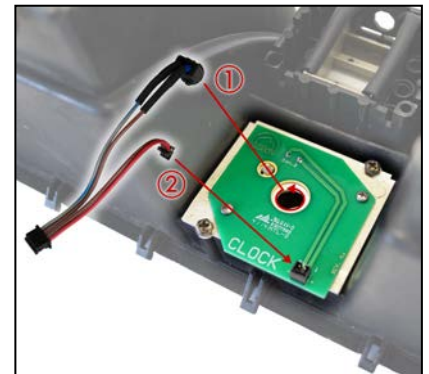

9. In order to block the illumination LED light from glowing behind the indicator LEDs, we will need to seal up the indicator LED channels first. Using a pair of scissors, slit the rubber tubing supplied with this kit down the entire length. Cut sections of the tubing and use them to seal off the indicator LED channels as shown in the diagram. The goal is to seal the top and rear edges of the white insert with one continuous length of material to prevent the center illumination LED light from bleeding into the indicator LED channels.

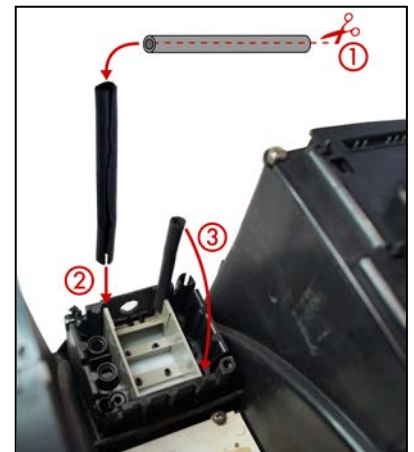

If you have a digital clock, **SKIP** step 10 and **PROCEED** to step 11.

10. Locate the analog clock harness included in your kit. Attach the right angle flag connector and the eyelet to the back of the analog clock as shown in the picture. We will install the other side of this harness when we install the main PCB board in a later step.

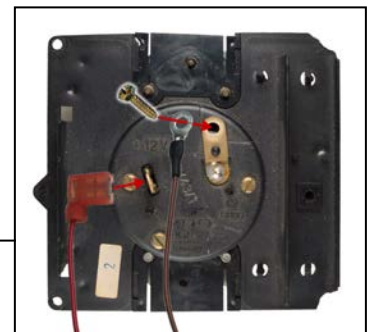



These instructions and the images herein are proprietary. Any unauthorized reproduction is prohibited.

GVW-255-919-059

## Gauge Cluster Printed Circuit Replacement

11. Now it is time to install the main PCB that we assembled in Steps 1 through 4. This board will be installed on the back of the cluster as shown. The small, blue, hi-beam indicator filter that is present in the cluster will have to be removed before installation to allow new LED to fit.

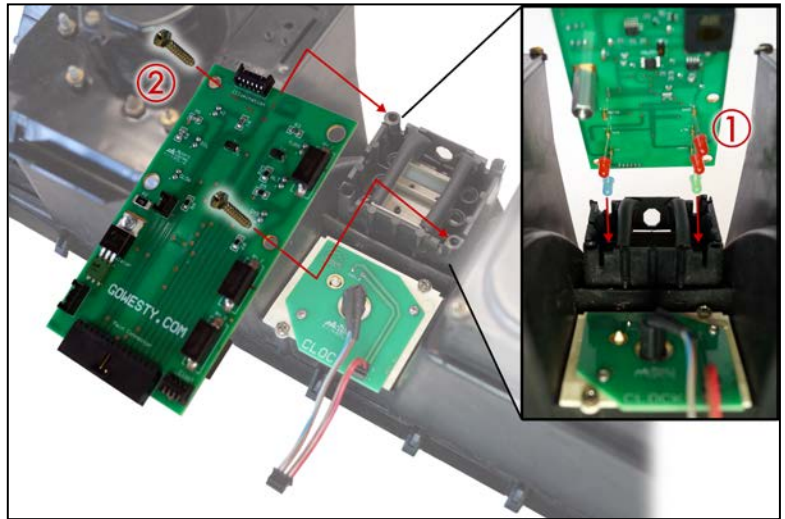

12. Now install the illumination LED harness included in this kit. Install the illumination LED sockets into the holes on the top of the cluster by twisting them 90 degrees. Connect the other side of this harness to the mating connector on the top of the main PCB. The harness should be installed exactly as indicated in the photo at right.

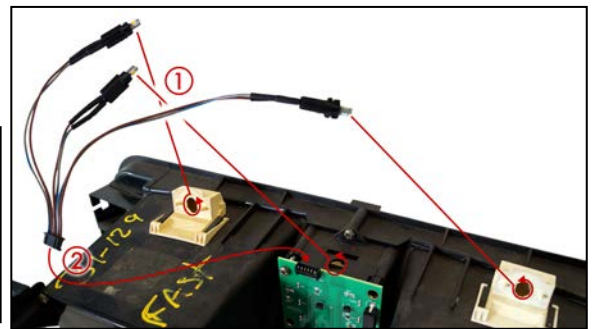

**NOTE:** There are several small O-rings included in this kit. If the LED connectors twist loosely into the cluster sockets, place the O-rings around the connector to tighten the fit.

13. The gauge harness will need to be installed next. Locate the gauge harness pictured to the right and install according to the diagram below.

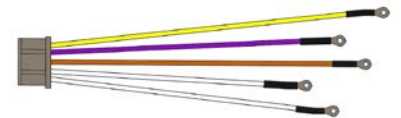

*Note: If you have an aircooled van, you will not have a coolant temperature gauge. The three wires (white, brown, and yellow/red) will not be used. Use some electrical tape to insulate the eyelets and tie these wires out of the way.*

### Tachometer Install

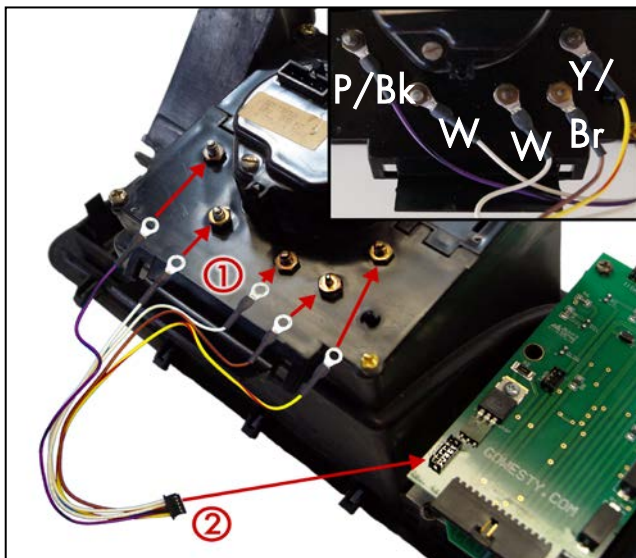

### Analog Clock Install

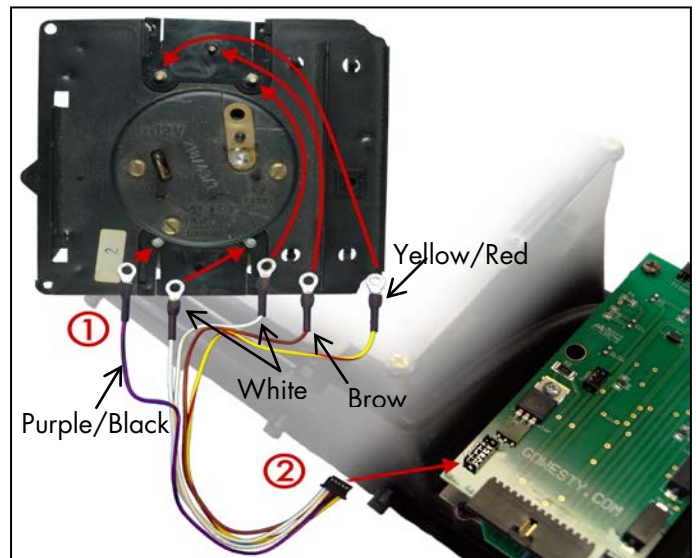



These instructions and the images herein are proprietary. Any unauthorized reproduction is prohibited.

GVW-255-919-059

## Gauge Cluster Printed Circuit Replacement

14. After the main board is installed, hook each of the remaining harnesses to the mating connectors located on the main board. Each connector will only mate in the correct direction in its proper place. Examples shown at right.

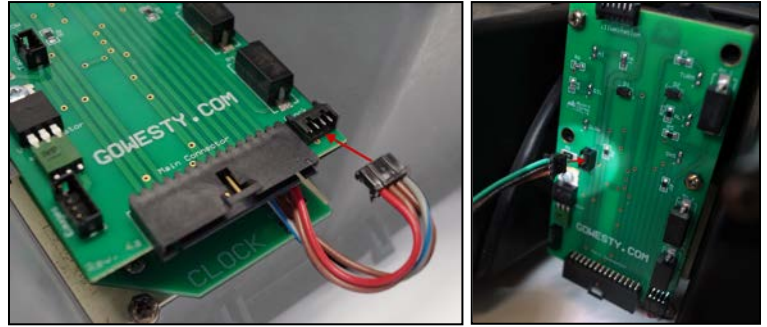

After all the harnesses are fully connected, use the included zip ties to secure the connector harnesses neatly to the cluster, as pictured below. Note: Picture is shown installed on a cluster with tachometer and digital clock.

When plugging the 14-pin PCB adapter into the white cluster connector on the vehicle harness, be sure the traces on the PCB adapter are oriented to make contact with the pins of the white connector.

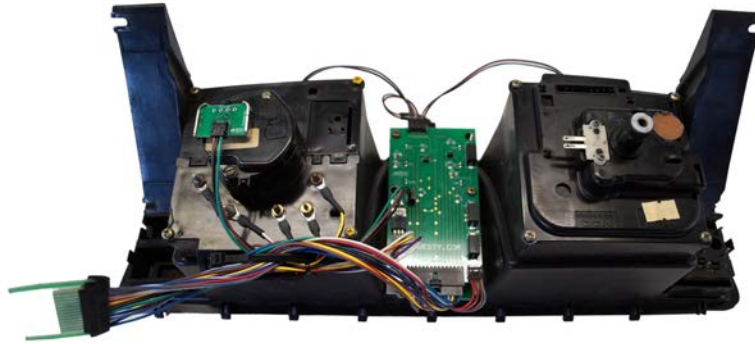

### Optional Cluster Reliability Connection:

If the factory white cluster connector located on the Vanagon wiring harness is damaged or corroded, you can always cut the PCB connector off of the main connector harness and splice the wires together directly. This will eliminate the extra connection point and make the wiring more reliable. The wire colors should match up appropriately.

*Note: This will permanently remove the white factory connector under the dash and replace it with the small black connector that mates directly to the main PCB.*

Join these wires permanently to the Vanagon factory wiring harness





## Retrofit Section

### Modifying the Vanagon Connector Wiring Order to Retrofit the GoWesty Harness into a 1980-85 Vanagon:

If you have a 1980-85 Vanagon, you will need to switch wires in the Vanagon's white harness connector to match the GoWesty Cluster Harness Plug. After switching the wires according to the chart titled GoWesty Cluster Harness Plug, the connector should look like Fig 1.

The wires can easily be switched into alternate spots in the factory white connector. To switch these wires, carefully open the hinged door on the white connector. Refer to the charts below, which indicate the placement of each wire for your particular model and the GoWesty Cluster PCB. Use these charts to match the wires in your white connector with the appropriate wires in the GoWesty Cluster PCB Plug. (A little help: The wire colors should be matched on each side after you are done switching the wires.)

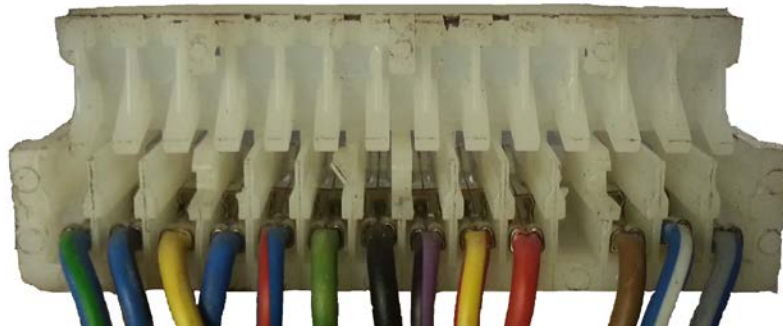

Fig 1: Wire positions after modifying connector (NOT STOCK FOR 80-85)

GoWesty Cluster Harness Plug			
Designed to plug-and-play 86-91 w/ Digital Clock, Tach, and Dynamic Oil Pressure System			
Pin	Wire Color	Function	
1	Grey w/Blue Stripe	Instrument Lighting	
2	Blue w/White Stripe	High Beam Light	
3	Brown	Ground	
4	White	To Bottom Right (typically Unused) LED indicator (ground to activate)	**Glow Plug Light on 83 Diesels
5	Red	LCD Clock	
6	Yellow w/Red Stripe	Coolant Temperature	
7	Violet w/Black Stripe	Fuel Gauge	
8	Black	Circuit 15 (Key on Power)	
9	Green	Tachometer	
10	Blue w/Red Stripe	Turn Signal Light	
11	Blue	Alternator Light	
12	Yellow	High Oil Pressure Light [Normally Open Switch]	**Used only in Dynamic Oil Pressure System 86-91
13	Blue w/Black Stripe	Low Oil Pressure Light [Normally Closed Switch]	
14	Blue w/Green Stripe	OXS Light	**Glow Plug Light on 82 Diesels



Instructions and the images herein are proprietary. Any unauthorized reproduction is prohibited.

GVW-255-919-059

Gauge Cluster Printed Circuit Replacement

Stock White Connector Wiring for 80-84 Vanagon (Excluding Wolfsburg Model)		
Pin	Wire Color	Function
1	N/A	Vacant
2	Brown	Ground
3	White w/Blue Stripe	Instrument Lighting
4	Blue w/White Stripe	High Beam Light
5	Brown	Ground
6	Yellow w/Red Stripe	Coolant Temperature
7	Red	Clock Power (If not installed, this is Vacant)
8	Violet w/Black Stripe	Fuel Gauge
9	Black	Circuit 15 (Key on Power)
10	Blue w/Black Stripe	Low Oil Pressure Light
11	Green w/Black Stripe (Blue w/Green Stripe)	OXS Light (Or Glow Plug Light on 83 Diesel)
12	White w/ Red Stripe	Glow Plug Light (1982 Diesel Only)
13	Blue	Alternator Light
14	Blue w/Red Stripe	Turn Signal Light

**\*\*Both ground wires will need to be spliced together. Be sure to combine this Brown ground wire with the Brown ground wire from pin 5 below.**

**\*\*Both ground wires will need to be spliced together. Be sure to combine this Brown ground wire with the Brown ground wire from pin 2 above.**

**\*\*Vacant on Air Cooled Vangons**

Stock White Connector Wiring for 85-91 Vanagon (Includes 84 Wolfsburg Model)		
Pin	Wire Color	Function
1	White w/Blue Stripe	Instrument Lighting
2	Blue w/White Stripe	High Beam Light
3	Brown	Ground
4	N/A	Vacant
5	Red	LCD Clock
6	Yellow w/Red Stripe	Coolant Temperature
7	Violet w/Black Stripe	Fuel Gauge
8	Black	Circuit 15 (Key on Power)
9	Green	Tachometer
10	Blue w/Red Stripe	Turn Signal Light
11	Blue	Alternator Light
12	Yellow	High Oil Pressure Light (Vacant on 84 wolfsburg & 85) [Normally Open Switch]
13	Blue w/Black Stripe	Low Oil Pressure Light [Normally Closed Switch]
14	Blue w/Green Stripe	OXS Light

**\*\*Used only in Dynamic Oil Pressure System 86-91**



Instructions and the images herein are proprietary. Any unauthorized reproduction is prohibited.

GVW-255-919-059

Gauge Cluster Printed Circuit Replacement

## Upside down tach board Modification:

In the rare case that your tachometer has the connector tab located at the bottom of the tach as shown in the picture to the right, you will need to rewire your tachometer harness according to the diagrams below. The wires and terminals can easily be removed from the 4 pin plastic connector with a small pick tool.



## Original Harness



## Harness Modified For Upside Down Tach Board

